

# INTEGRATED E-Z SPLIT KEY® CUP II Procedure Card

## Available with Specimen Validity Tests (S.V.T.)

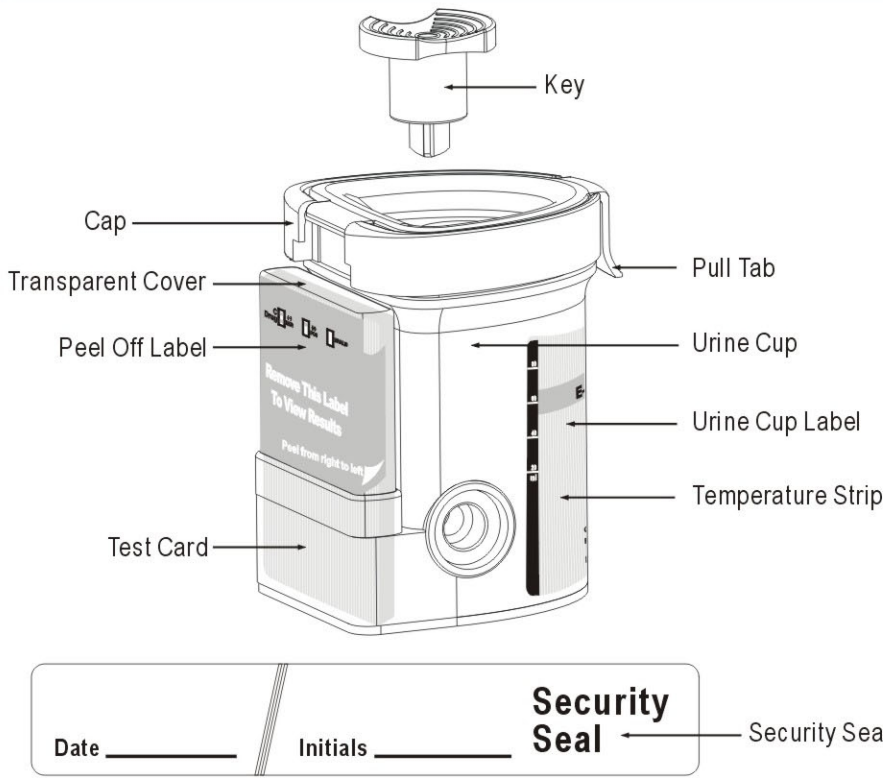

**1** Remove the key by twisting it from the center of the cup cap. Open cap with the Pull Tab. (Key is held by technician.)

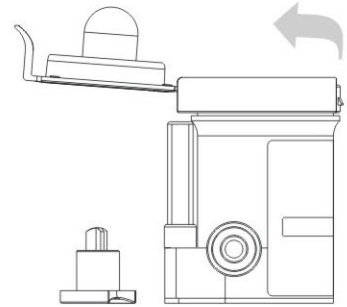

**2** Donor provides specimen and secures cap. Note: Secure cap by pressing down on the Pull Tab until an audible click is heard.

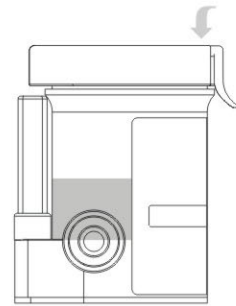

**3** Check cap for tight seal. Technician dates and initials the security seal and places security seal over cap.



Place security seal over cup



**4** On a flat surface, technician inserts key and pushes in.

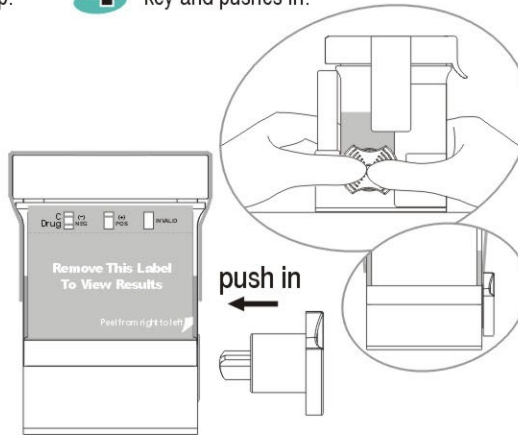

**5** Peel off the label to view results.

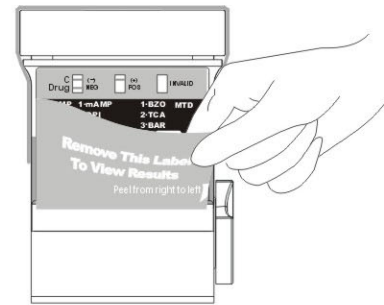

**6** If the test cup includes S.V.T., read adulteration test results between 3 - 5 minutes.

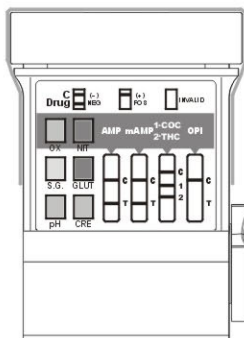

3 - 5 minutes

Adulteration Strips  
See color chart and package insert for interpretation.

**7** Read drug test results at 5 minutes.

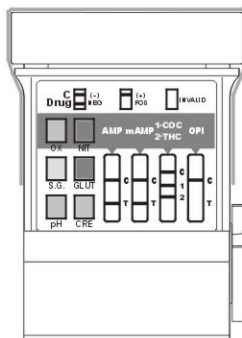

Example: Test shows positive for OPI.



**C** Drug **NEGATIVE**

**C** Drug **POSITIVE**

**C** Drug **INVALID**

All positive results are presumptive and should be confirmed by an alternative method. (e.g. GC/MS)

**8** A photocopy of the drug test results can be made by placing the entire cup with the card face down on the copier.

